

Article number: 2030120M24200A2U

Description: E+G levelling foot
GN 30-120-M24-200-A2-U

Note: U Without nut, Hexagon socket at the top, Wrench flat at the bottom

Measures

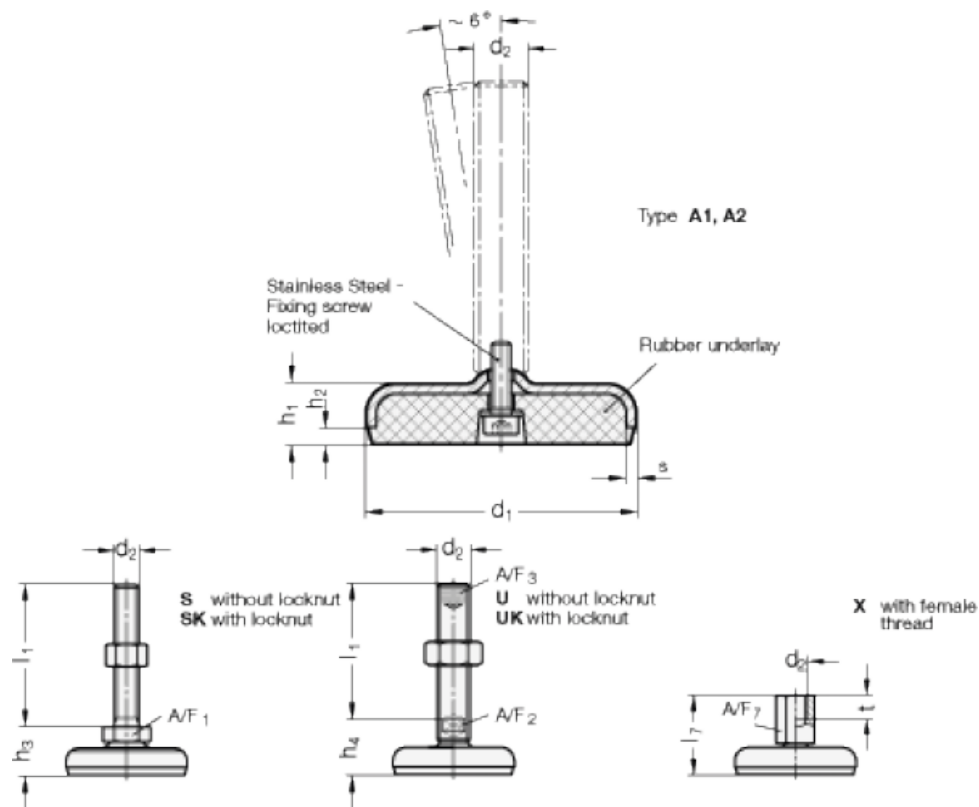

A/F2 = 19
A/F3 = 12
 d_1 = 120
 d_2 = M24
 h_1 = 22
 h_2 = 6
 h_4 = 42
 l_1 = 200

s = 4